

# HL616/1

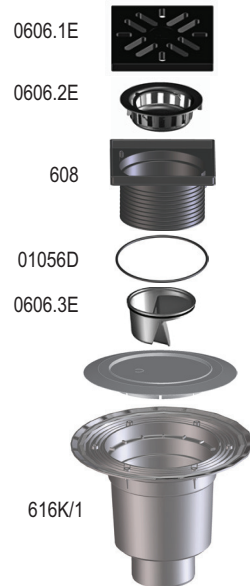

5,5 l/s  
DN110

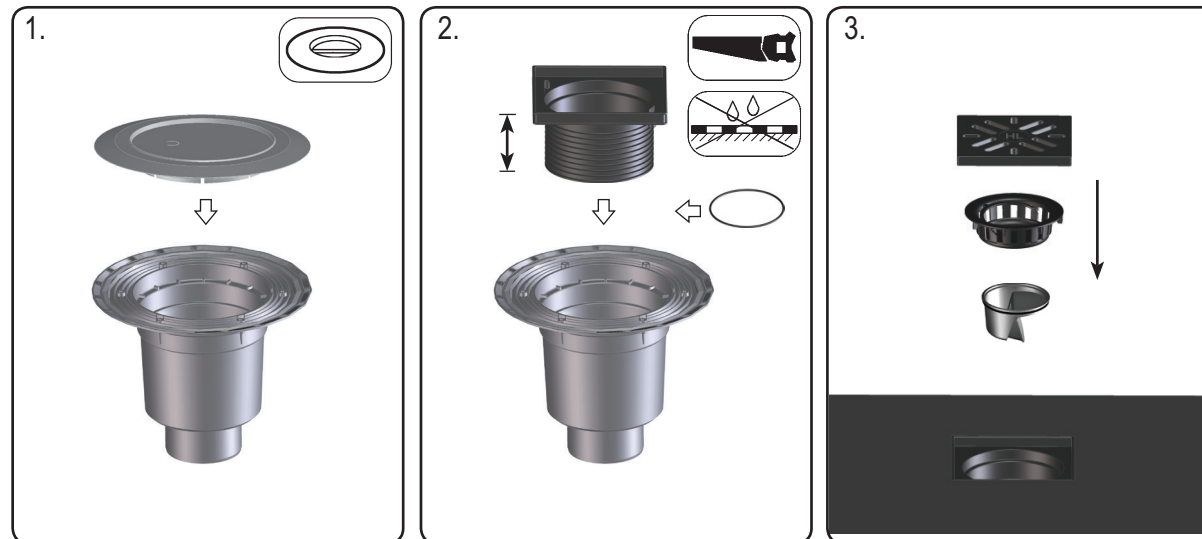
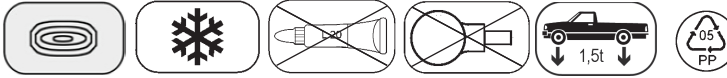

**D** Großablauf  
**I** GRANDO SCARICO  
**GB** MAJOR DRAIN

**TR** BÜYÜK ÇAPLI SÜZGEÇ  
**CZ/SK** VELKOKAPACITNÍ ODTOK  
**HR** VELIK SLIVNIK

**H** NAGYLEFOLYÓ  
**PL** WPUST PODWÓRZOWY  
**SLO** VELIKI ODTOK

**RO** RECEPTOARE MARI  
**PYC** Дворовый трап  
**BUL** Голям сифон

23.09.2010