

HL62BH/7 6,00 l/s DN75

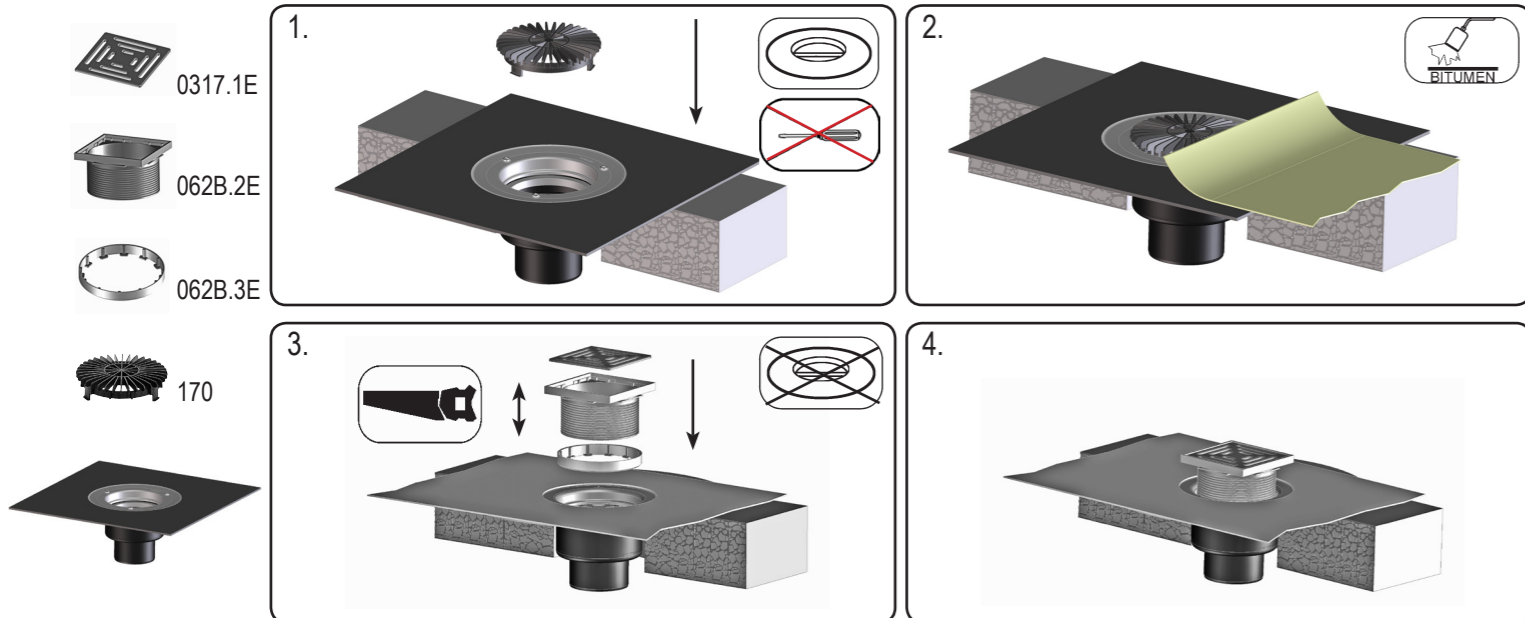

D Flachdach-Ablauf
I Scarico per tetti piani
GB Flat-roof drain
TR Düz çatı süzgeci
CZ/SK Střešní vtok
EX-YU slivnik za ravni krov
H Lapostető lefolyó
PL Wpust dachu płaskiego
SLO Odtok ravne strehe
RO Scurgere de pe terase
PYC Воронка для плоской кровли
BUL воронка за плосък покрив

14.07.2017

HL62BH/7 6,00 l/s DN75

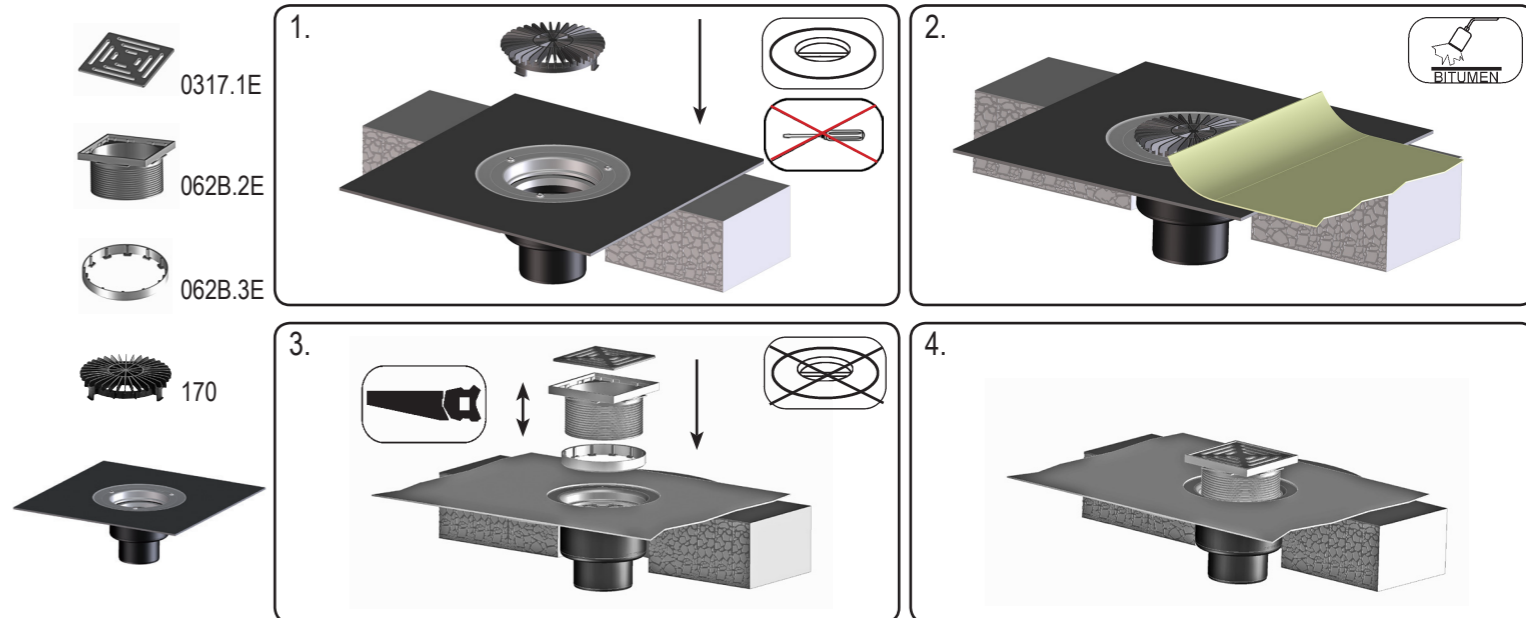

D Flachdach-Ablauf
I Scarico per tetti piani
GB Flat-roof drain
TR Düz çatı süzgeci
CZ/SK Střešní vtok
EX-YU slivnik za ravni krov
H Lapostető lefolyó
PL Wpust dachu płaskiego
SLO Odtok ravne strehe
RO Scurgere de pe terase
PYC Воронка для плоской кровли
BUL воронка за плосък покрив

14.07.2017

HL62BH/7 6,00 l/s DN75

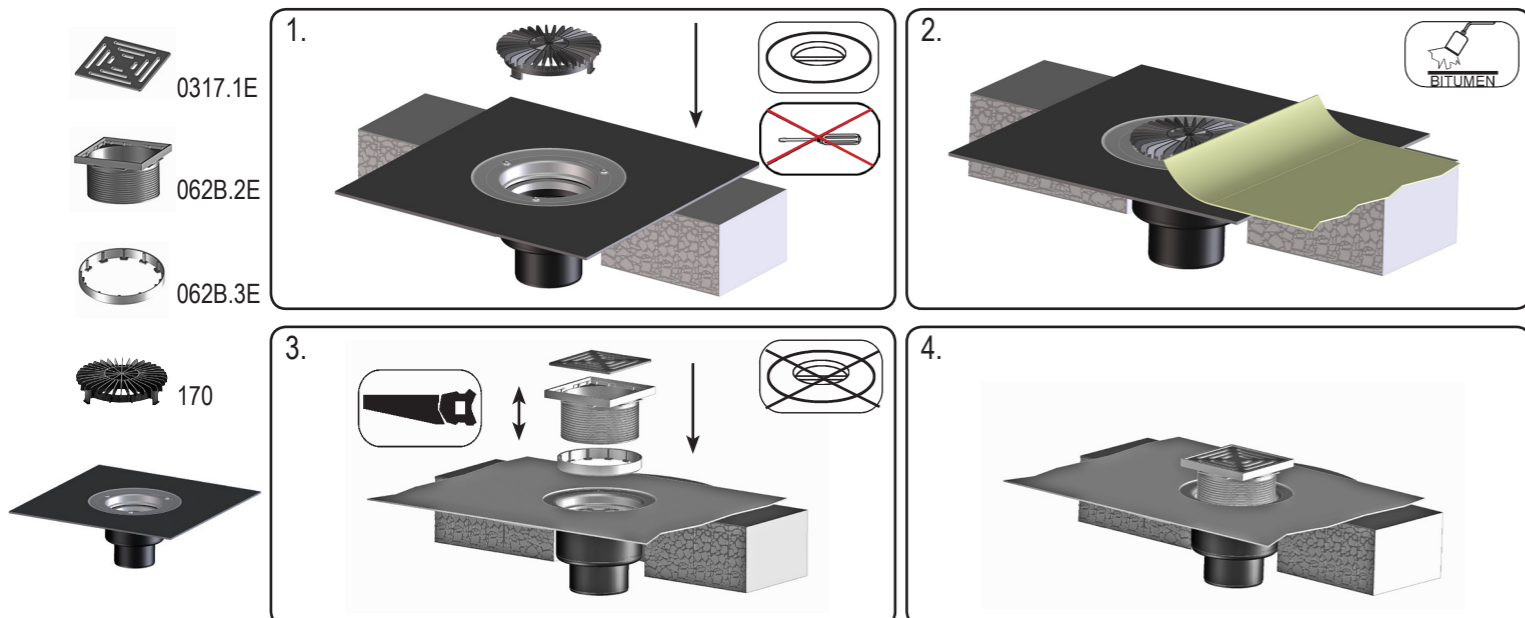

D Flachdach-Ablauf
I Scarico per tetti piani
GB Flat-roof drain
TR Düz çatı süzgeci
CZ/SK Střešní vtok
EX-YU slivnik za ravni krov
H Lapostető lefolyó
PL Wpust dachu płaskiego
SLO Odtok ravne strehe
RO Scurgere de pe terase
PYC Воронка для плоской кровли
BUL воронка за плосък покрив

14.07.2017

HL62BH/7 6,00 l/s DN75

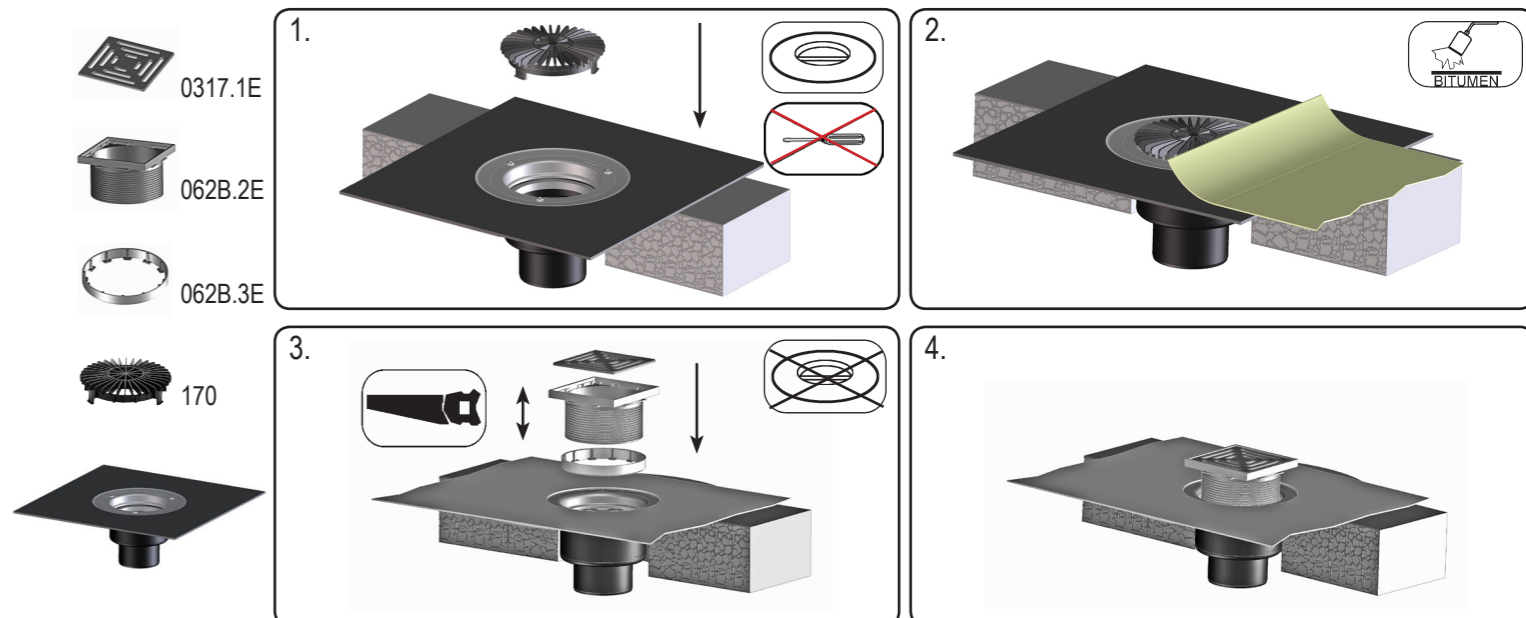

D Flachdach-Ablauf
I Scarico per tetti piani
GB Flat-roof drain
TR Düz çatı süzgeci
CZ/SK Střešní vtok
EX-YU slivnik za ravni krov
H Lapostető lefolyó
PL Wpust dachu płaskiego
SLO Odtok ravne strehe
RO Scurgere de pe terase
PYC Воронка для плоской кровли
BUL воронка за плосък покрив

14.07.2017