

Ø 500

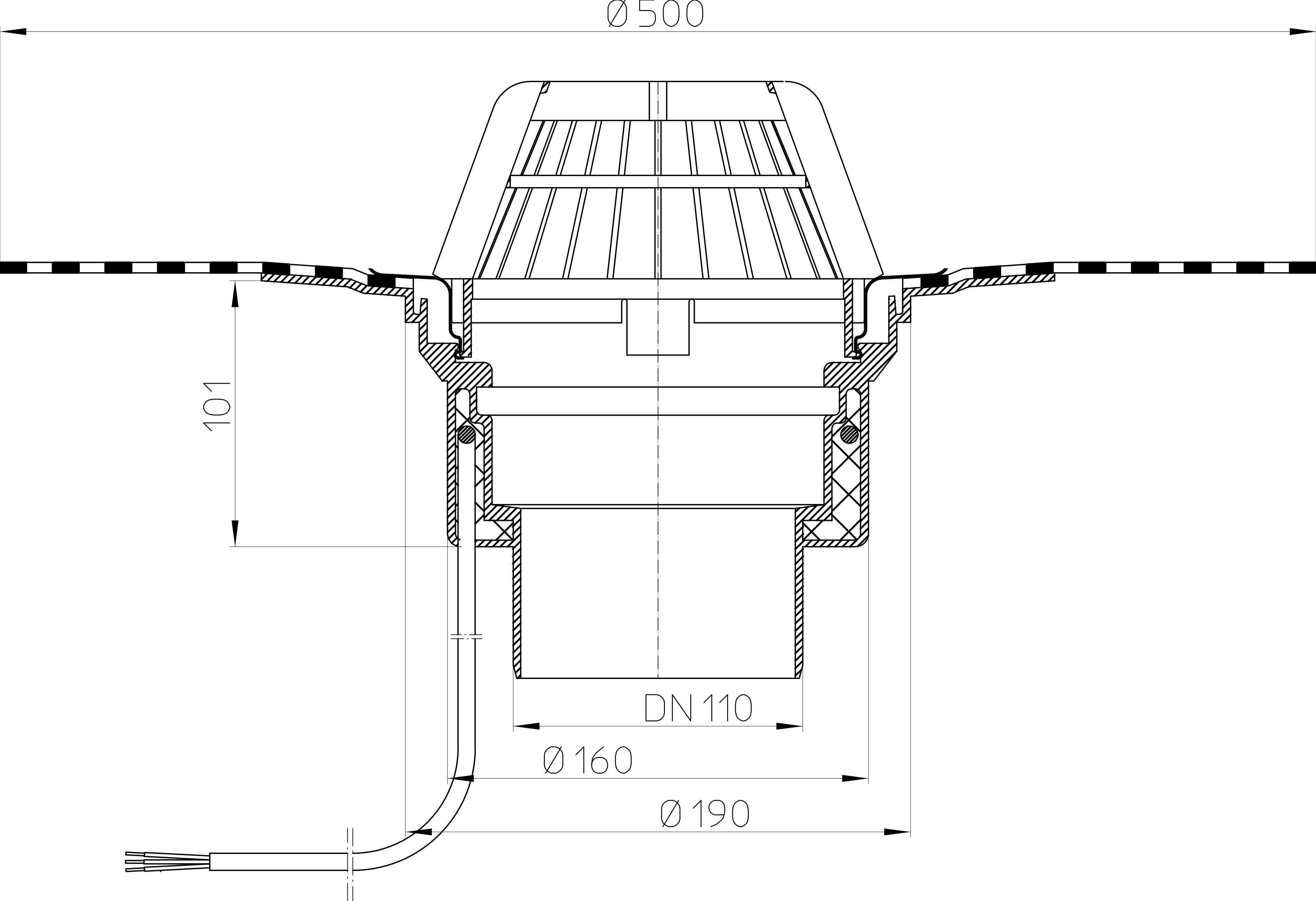

101

DN 110

Ø 160

Ø 190